

This document is our property and shall not without our permission be altered, copied, used for manufacturing or communicated to any other person or company.

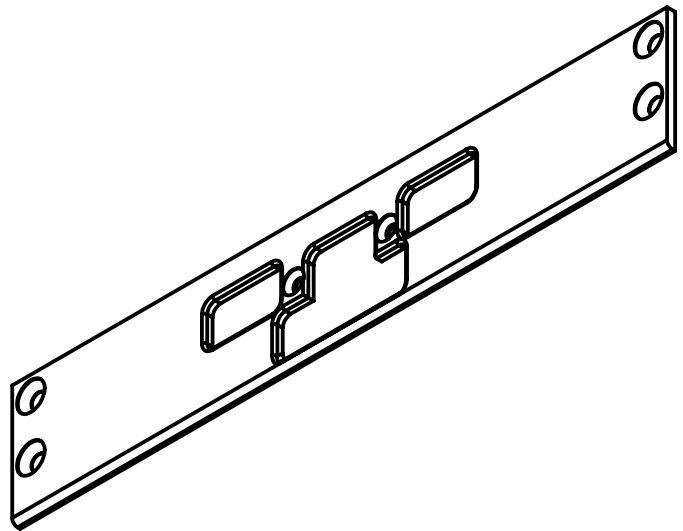
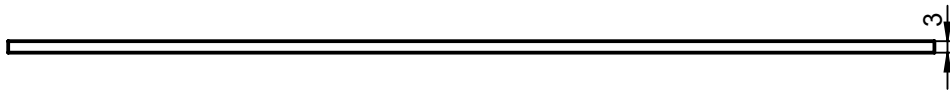
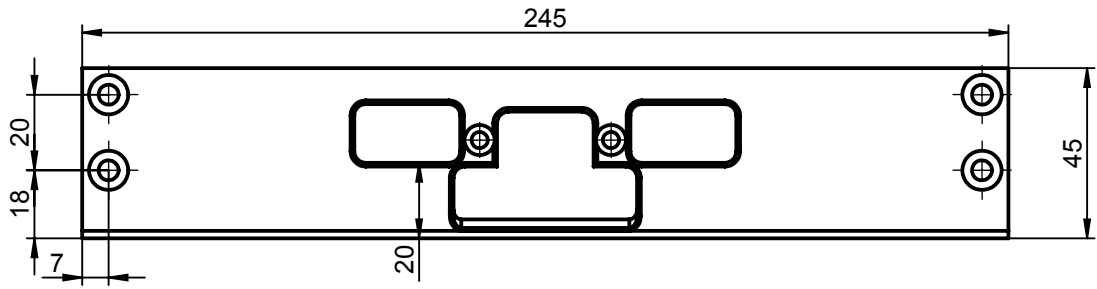

Surface:			Material:			General tolerance: ISO 2768-fH		
Volume: 26154.13 mm ³	Weight: 26.15 gram	Surface area: 20526.48 mm ²	created: 2013-06-20	designed by: JoEr	changed by: JoEr	Scale: 1:5 (A4)	Projection:	
ASSA ABLOY ASSA AB			Mounting component 931-20 710.500-00-24-1-1000			Drawing number: is the valid ID if displayed		
						Document: 01	Item number: 000055725	Revision: 1