

This work is copyright and no part may be reproduced, by any process, nor may any other exclusive right be exercised without the permission of ASSA ABLOY.

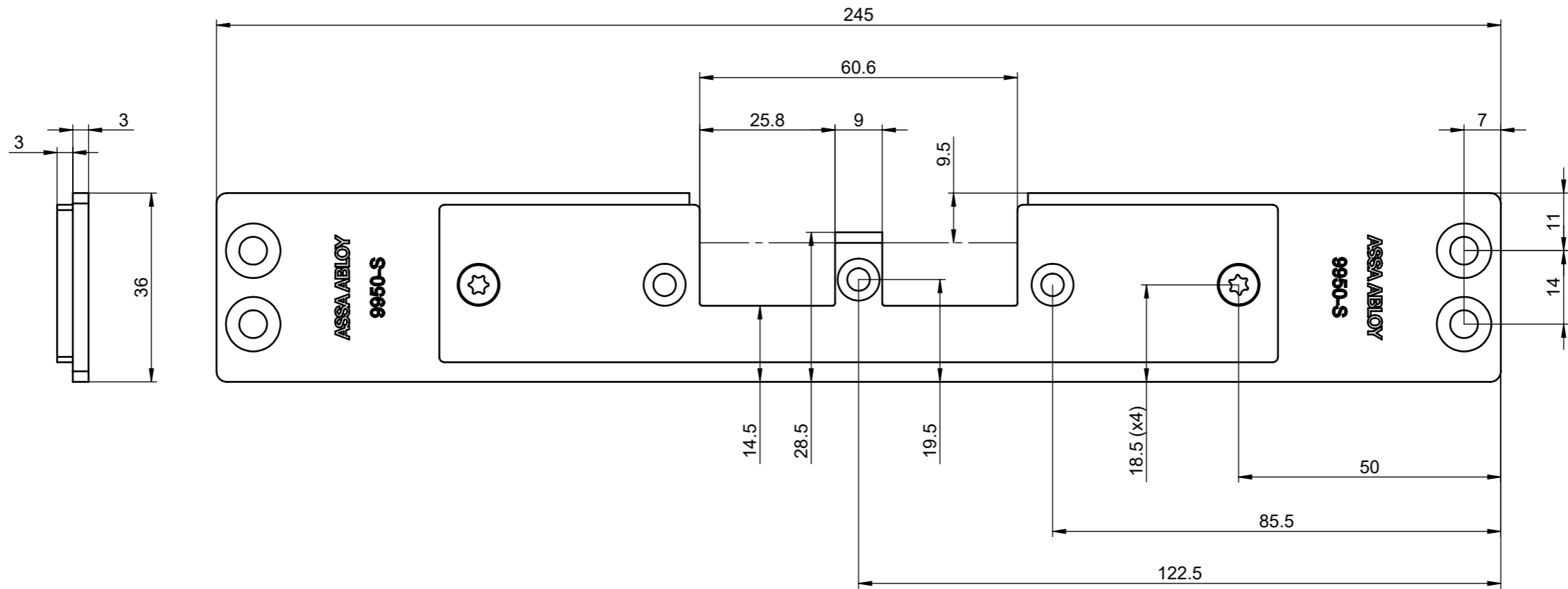

Surface:			Material:			General tolerance:	
Volume: 24878.73 mm <sup>3</sup>	Weight: 194.05 gram	Surface area: 21326.74 mm <sup>2</sup>	Created (YYYY-MM-DD): 2020-06-01	Designed by: HrHa	Drawn by: HrHa	Scale: 1:1 (A3)	Projection: 
<b>ASSA ABLOY</b> ASSA ABLOY Scandinavia			Mortise drawing Faceplate 9950-S ASSA 992			Alternate ID	
						Document ID <b>D001081491-002</b>	Rev.: <b>1</b>

Approved 2020-06-17

Configuration:Default

SHEET 1 OF 1